



TiF-SP. Ti:Sapphire Femtosecond Solid-State Oscillator

- Pulse duration 12...50 fs
- Output power 230...1300 mW
- Tuning range 750-860 nm
- Monolithic thermally stabilized body
- Motorized USB wavelength tuning (optional)
- Automatic mode-locking (optional)
- Integrated spectrometer and power meter (optional)



The TiF-SP-TU Ti:Sapphire femtosecond laser with an integrated pump source

Product overview

The TiF-SP laser system offers the shortest available pulse duration in the TiF family of Ti:S femtosecond laser oscillators. It is a robust tool for cutting-edge ultrafast research.

The system can be supplied as a stand-alone version for pumping with an external pump laser or as a version with an industry-standard pump laser integrated on site or at our factory. However, the dimensions of the Ti:S laser head are the same for either version, the stand-alone version may later be fitted with an integrated pump laser at minimum additional cost. The acceptable pump laser power for the TiF-SP is up to 10 W.

The system is designed to operate 24/7 as a seed oscillator for larger amplifier systems and thus inherits all the stability-enhancing design features. The system may be supplied pre-tuned to one of available pulse duration configurations (12, 15, 30 or 40 fs), with all the components inside the box being the same, or it can be equipped with an additional option to switch between these ranges. In this case, the broadness of the central wavelength tuning range of the spectrum increases with increasing pulse duration.

There are three pre-designed factory supply packages:

- the 'Manual' factory package includes a push-button non-automatic electric starter and allows manual tuning of the wavelength and pulse duration setting by using micrometer screws placed on the walls of the laser box.

- the 'Basic' factory package includes a simple USB motorized wavelength tuning slit and a push-button non-automatic electric starter. Wavelength tuning and calibration with this package is done via step number information in basic Windows software.

- the 'Auto' factory package includes built-in spectrometer and power meter, single-touch wavelength tuning with presets, configurable widget software, active power lock function and automatic mode-lock start and monitoring. With this package the system boasts exceptional long-term stability and longer uninterrupted runtime.

The monolithic thermostabilized body of the TiF-SP provides excellent passive stability of the output radiation parameters.

An external prism pair or tunable pulse compressor (model APC) for output pulse chirp compensation and pre-compensation are also available.

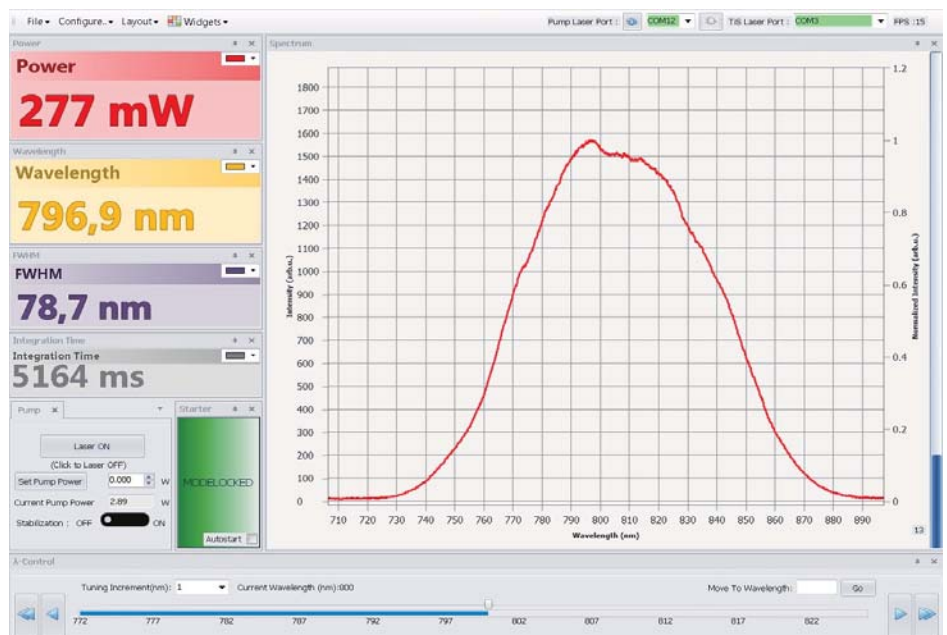

Widget-based software screenshot for the TiF family of lasers with integrated spectrometer ("Auto" package)

Possible applications of the TiF Series lasers:

- Seed oscillator for amplifier systems
- Terahertz generation
- "Pump-probe" spectroscopy
- Optical coherent tomography
- Optical frequency metrology
- Multiphoton microscopy
- Semiconductor device characterization
- Fundamental Research

| | TiF-SP-12 | TiF-SP-15 | TiF-SP-30 | TiF-SP-40 | TiF-SP-TU | | |
|---|-------------------|------------|------------|------------|--------------------|------------|---------|
| Compressed pulse duration with external compressor^{1),5)} | <12 fs | <15 fs | <30 fs | <40 fs | 15-50 fs (tunable) | | |
| Spectrum width (FWHM)¹⁾ | >80 nm | >60 nm | >30 nm | >20 nm | from 18 nm | to 65 nm | |
| Central wavelength tuning | 800±15 nm (fixed) | 790-820 nm | 770-840 nm | 750-860 nm | 790-820 nm | 750-860 nm | |
| Output power²⁾ | | | | | | | |
| Pump laser power | 3 W | >230 mW | >280 mW | >350 mW | >400 mW | >380 mW | >230 mW |
| | 4 W | >330 mW | >350 mW | >470 mW | >530 mW | >500 mW | >300 mW |
| | 5 W | >400 mW | >500 mW | >550 mW | >600 mW | >570 mW | >380 mW |
| | 6 W | >500 mW | >650 mW | >750 mW | > 800 mW | >750 mW | >450 mW |
| | 10 W | >850 mW | >1000 mW | >1200 mW | >1300 mW | >1200 mW | >800 mW |

General optical specifications

| | |
|---|--|
| Pulse repetition rate (fixed) | 80±10 MHz |
| Pump laser | integrated or stand-alone DPSS 532 nm low-noise laser (up to 10 W) |
| Beam mode | TEM ₀₀ |
| Beam diameter (at 1/e²) | <2 mm |
| Output polarization | linear, horizontal, PER >20 dB |
| Beam divergence | <1 mrad |
| Long-term stability²⁾ | <0.2% rms |
| Noise⁴⁾ | <0.1% rms |

Physical dimensions (L × W × H)

| | |
|---|--|
| Laser head dimensions | 513 × 268 × 120 mm (including integrated pump laser) |
| Pump laser control unit dimensions | 353 × 360 × 119 mm |
| Closed-loop chiller dimensions | 430 × 340 × 190 mm |

Environmental and utility specifications

| | |
|------------------------------|-------------------------------------|
| Operating temperature | 15-30 °C |
| Relative humidity | <60%, non-condensing |
| Voltage | single-phase; 100-240 VAC; 50/60 Hz |
| Power consumption | <2 kW |

Available configuration packages³⁾

| | |
|--|--|
| Thermally stabilized monolithic body | included in any package |
| Pulse train SMA output with mode-lock LED | included in any package |
| 'Auto' factory package | <ul style="list-style-type: none"> - built-in spectrometer - single-touch wavelength tuning w. presets - built-in power meter - active output power stability locking - Windows software with configurable widgets - automatic mode-lock start and monitoring PC requirements: USB 2.0 port, Windows 10 |
| 'Basic' factory package (default) | <ul style="list-style-type: none"> - mode-lock LED and push-button starter - USB 2.0 wavelength tuning via step-motor slit (via step number information and calibration) PC requirements: USB 2.0 port, Windows 10 |
| 'Manual' factory package | <ul style="list-style-type: none"> - push-button starter - manual wavelength tuning slit |

1) - when tuned to 800 nm central wavelength;

2) - after 30 min warm-up with cold start, during 12-hour continuous operation under equal room temperature conditions using recommended stabilized closed-loop chiller with proper capacity and recommended low-noise on-board integrated highly stable pump laser with active power locking;

3) - please select one of the packages for your system; certain features may be tailored or combined differently according to specific customer requirements;

4) - measured from 10 Hz to 10 MHz;

5) - external compressor is not included.

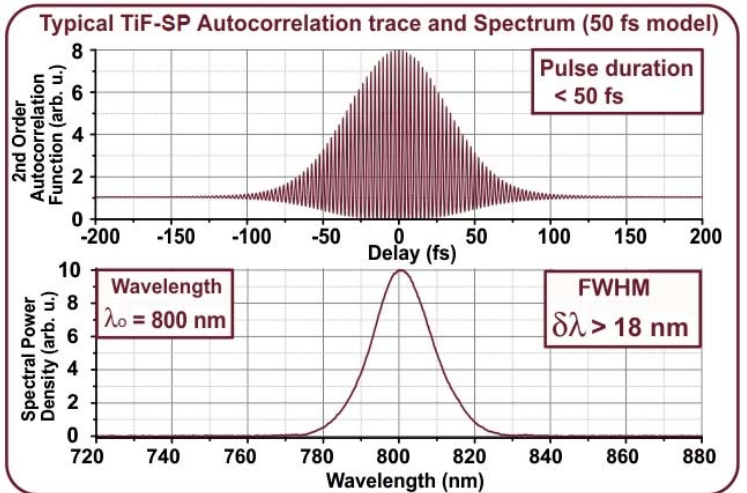
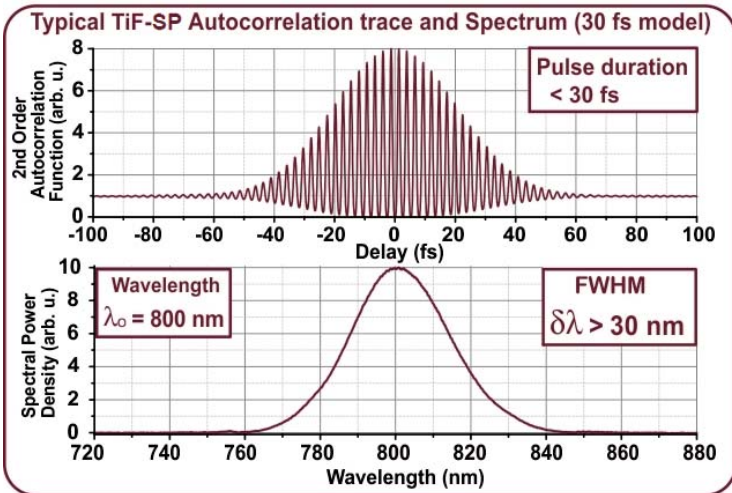
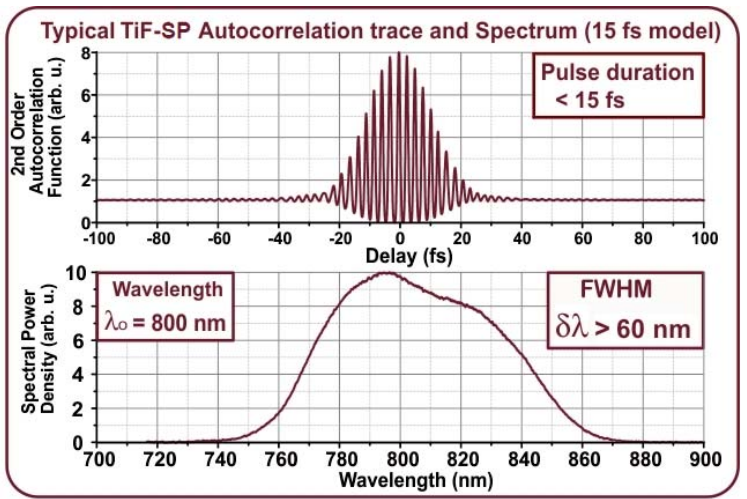
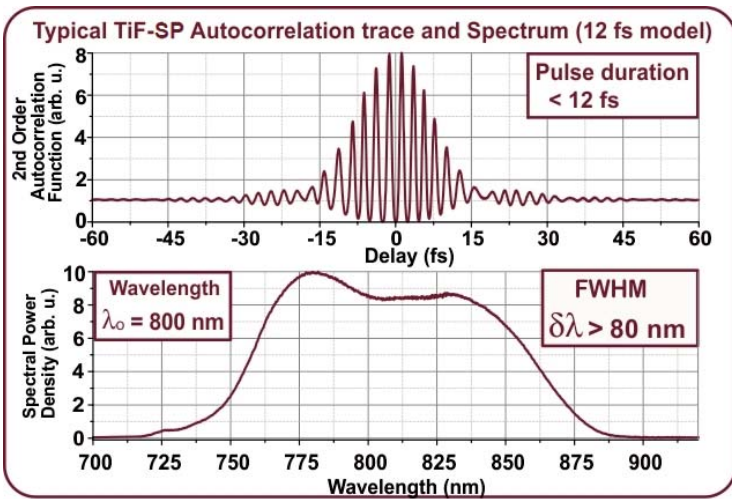

Possible factory configurations of the TiF-SP system for various output pulse durations

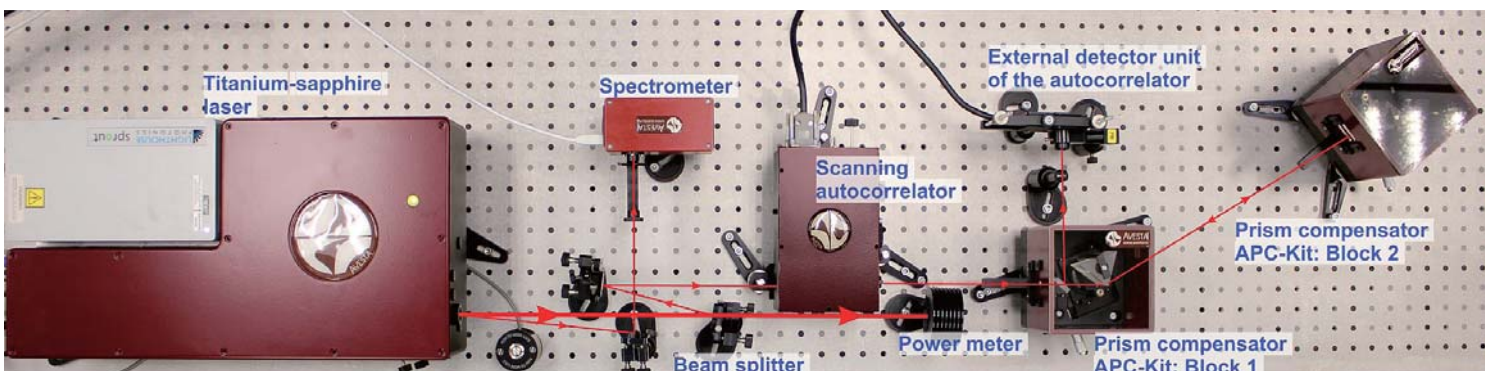
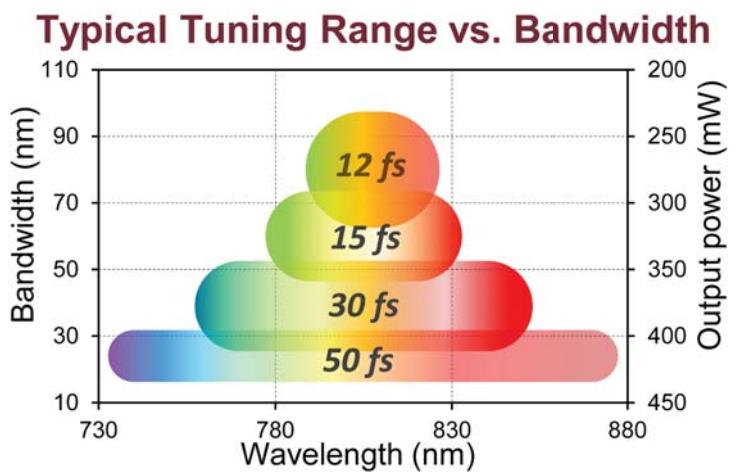
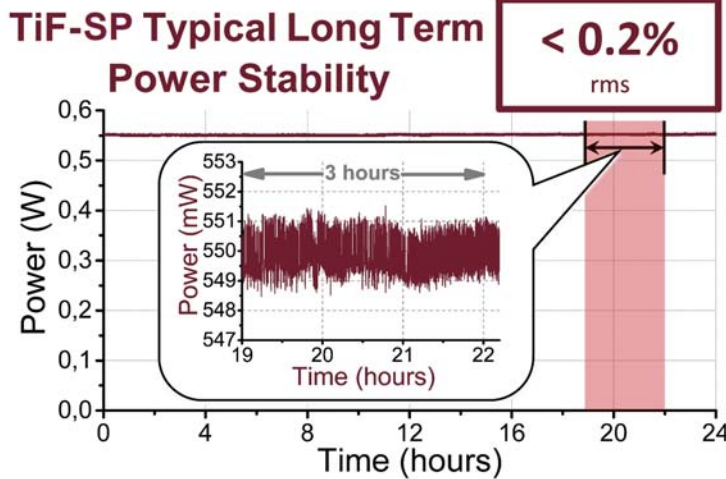

Possible total dispersion control setup for multi-photon microscopy applications with TiF Series laser, APC Kit dispersion compensator and AA-M scanning autocorrelator with an external detector unit

TiF-SP laser head dimensions

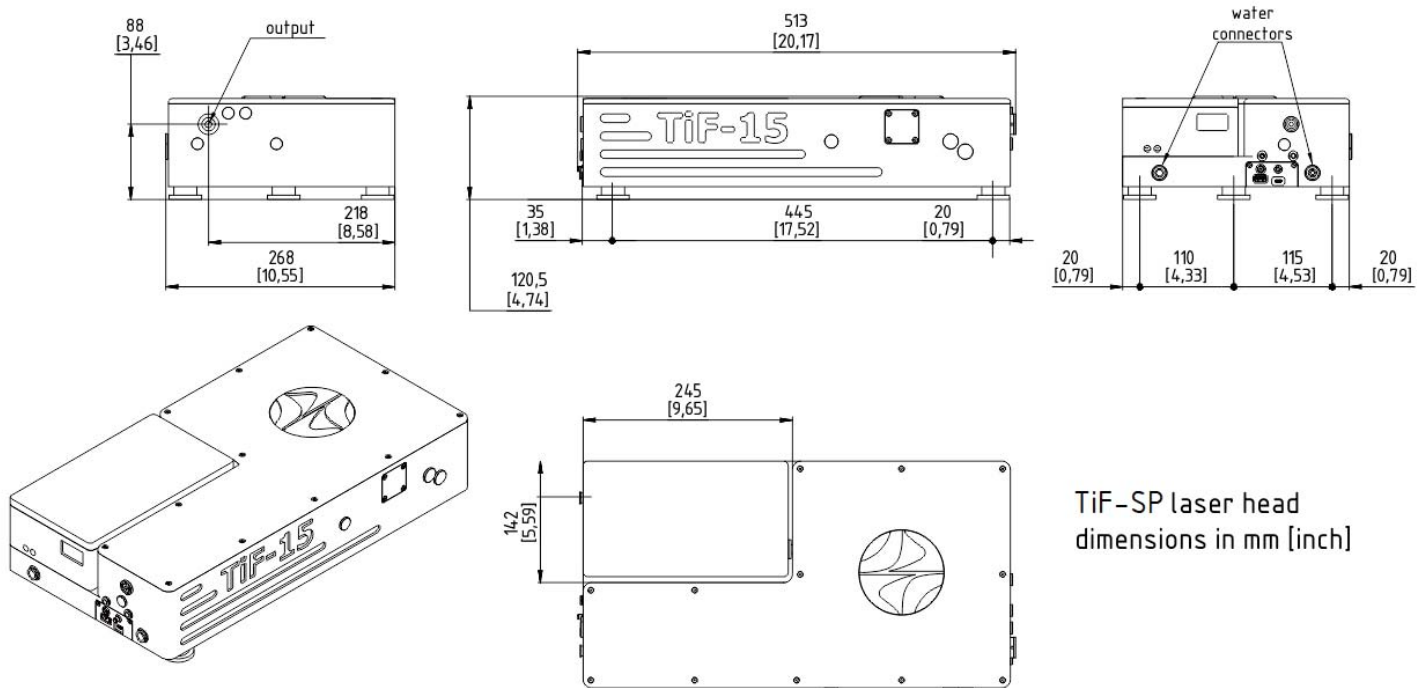

TiF-SP laser head
dimensions in mm [inch]

Dimensional drawing of TiF-SP laser with an integrated DPSS pump laser